

FP series

3 / 3x / 3-ir / 3x-ir

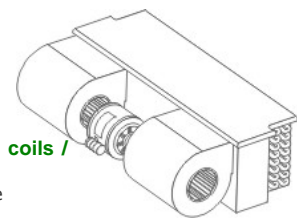

To be used with:
**Horizontal room fan coils /
Ducted fan coils**

- 7 days programmable
- 3-speed fan control
- Simultaneous indication of room & desired temperature
- Animated screen
- Bilingual

CLIMASET®
Interactive Controllers

Climaset is under continuous development. There is no warranty about accuracy and reliability of the contents of this document. Both the described products and document contents may be changed or withdrawn without any previous notice. There is no responsibility for any damages or loss, even indirectly, howsoever caused.

Copyright © 2005 Climaset. All rights reserved.

User's Guide

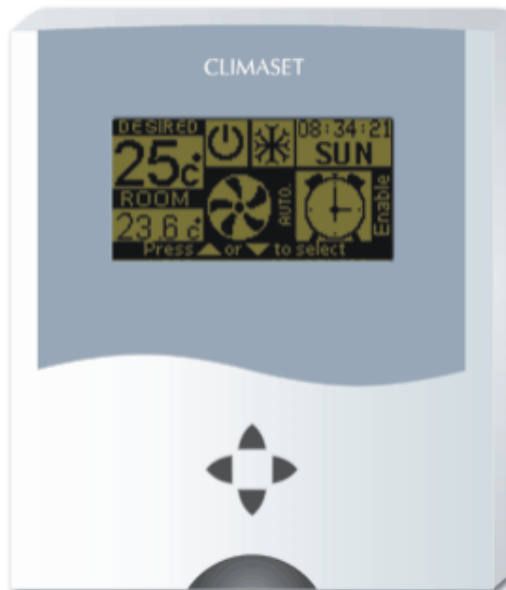

Contents

1. Your Climaset.....	4
2. Wall mounted unit	4
2.1. Keys and infrared sensor	4
2.2. Screen elements	5
2.3. Using the menu in primary screen	6
2.4. To set the schedule program	8
3. Remote controller unit (FP 3-ir / 3x-ir only)	9
3.1. Installing batteries for remote controller	9
3.2. Keys	10
3.3. Screen elements	11
3.4. List of status bar messages	11
4. Installation guide.....	12
4.1. Mounting the wall mounted unit	12
4.2. Proper wiring technique for the wall mounted unit	12
4.3. Engaging the wall mounted unit	12
4.4. Wall mounted unit connectors	13
4.5. Wiring diagram.....	13
5. Care and maintenance	14
6. Specifications	14

1. Your Climaset

Climaset FP 3/3-ir/3x/3x-ir state of the art series are designed to work in conjunction with horizontal room fan coils / ducted fan coils to achieve the maximum energy saving while the room temperature maintains at comfort level whenever necessary. Each of the mentioned models consists of a wall mounted unit. Also a remote control option is available for 3-ir/3x-ir.

- ❶ Wall mounted unit
- ❷ Remote controller (Optional FP 3-ir / 3x-ir only)

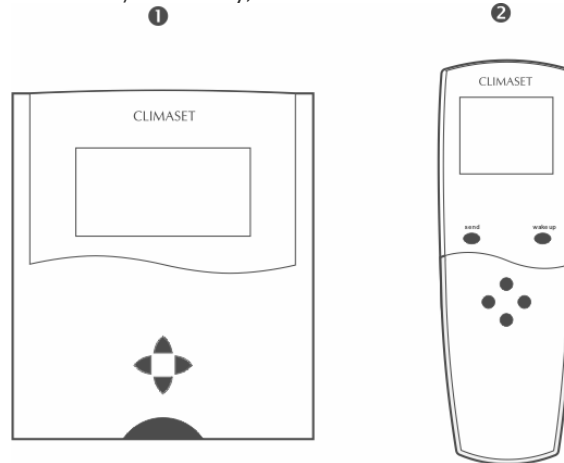

2. Wall mounted unit

The wall mounted unit has the following functions:

1. Measurement of room temperature.
2. Interaction with user to adjust the set points.
3. Interaction with the remote controller (FP 3-ir / 3x-ir only).
4. Interaction with fan coil to adjust the desirable fan speed.

2.1. Keys and infrared sensor

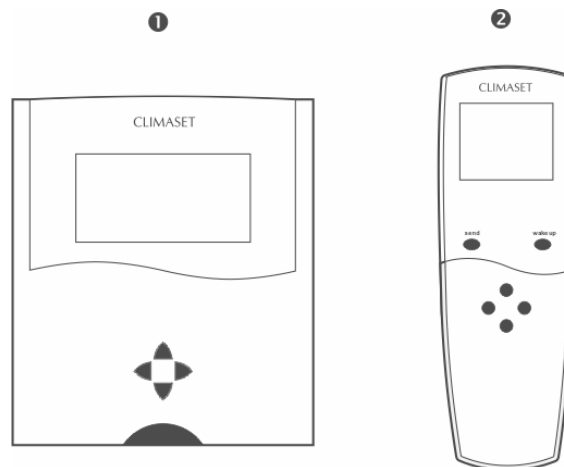

- ❶ "Up" and ❷ "Down"
Use these keys to scroll the menus.
- ❸ "Right" and ❹ "Left"
Use these keys to adjust the values in each menu item.
- ❺ "Power"
On/Off switch.
- ❻ "Infrared sensor" (FP 3-ir / 3x-ir only)
Intended to receive the remote controller commands.

2.2. Screen elements

2.2.1. Primary screen elements

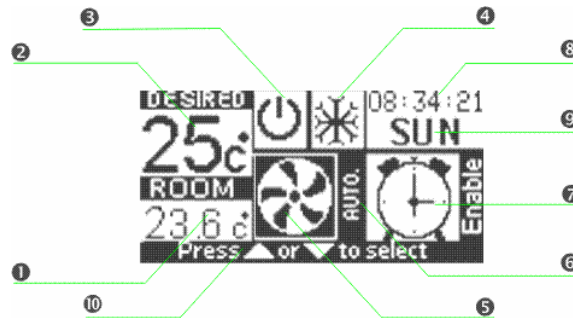

❶ Room temperature: Indicates the current room temperature.

❷ Desired temperature: Your desired room temperature.

❸ Power status:

- Ⓛ Air conditioner apparatus is on.
- Ⓜ Air conditioner apparatus is off.

❹ Season setting:

- ☀ The device is adjusted to work in summer.
- ❄ The device is adjusted to work in winter.

❺ Fan status: Indicates a schematic of the selected fan speed. The number of the blades is proportional to the selected fan speed.



High speed



Medium speed



Low speed

❻ Auto: This icon appears if the "Auto" mode is selected. It means the device automatically selects the appropriate fan speed which is proportional to the temperature difference between the room and desired. So by approaching to the desired temperature the fan speed reduces. The feature is called "smooth approach" and is only available in FP 3x/3x-ir.

❼ "Enable/Disable Program": Indicates if the schedule program is enabled or not. If it is disabled thermostat automatically controls the air conditioner, according to temperature, regardless of the schedule.

❽ Clock: Digital clock.

❾ Day: Weekly calendar.

❿ Status bar: Indicates the "Menu item" you wish to adjust. Use "Up" or "Down" keys to surf through these menus (Refer to section 2.1 for "Up" and "Down" keys).

2.2.2. Schedule settings screen

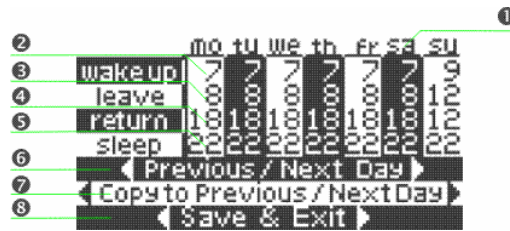

- ❶ "Title bar": This row represents the titles of the days of the week.
- ❷ "Wake up": It represents the wake up time in hours. The air conditioner starts working at this time.
- ❸ "Leave": It indicates the leave time in hours. It is the time when every one in the house leaves to work. The air conditioner shuts down automatically at this time.
- ❹ "Return": It is the time in hours which the first person returns to home from work. The air conditioner restarts at this time.
- ❺ "Sleep": When every one goes to sleep and you want the air conditioner to shut down.
- ❻ "Previous/Next Day": By pressing "Right" or "Left" key when this row is blinking you can move to the next or previous day settings.
- ❼ "Copy to Previous/Next Day": It copies blinking day column settings to the next or previous day depends on whether "Right" or "Left" key is pressed and moves to the related day.
- ❽ "Save & Exit": It saves the changes and returns to the primary screen.

Note: You can bypass the off period between leave and return by selecting the same time for both.

2.3. Using the menu in primary screen

2.3.1. Accessing a menu function

Scroll with the "Up" or "Down" keys to access the desired menu function. Use "Right" or "Left" keys to adjust the set points (Refer to section 2.1 for "Up", "Down", "Right" and "Left" keys)(Refer to section 2.3.3 on adjusting set points and their functions).

2.3.2. List of menu functions

1. Fan speed
2. Desired temperature
3. Season setting
4. English/Local
5. Adjust hour
6. Adjust minute
7. Adjust day
8. Enable/Disable program
9. Weekly program settings

2.3.3. Menu functions

❶ Fan speed (Menu item 1)

It represents the adjusted fan speed. Use "Left" key to decrease the fan speed or "Right" key to increase it.

Note: If the fan speed is set to its minimum value and "Left" key is pressed the power status will be switched off. It switches on again by pressing the "Right" key.

Notice: Pressing the "Right" key while the maximum fan speed is selected enables the "Auto" mode (FP 3x/3x-ir only) (Please refer to section 2.2 for more description on "Auto" mode). You may exit the "Auto" mode by

CLIMASET

pressing the "Left" key in "Fan speed" menu, which cause the device to return to the maximum fan speed again.

② Desired temperature (Menu item 2)

It is the temperature which you like to maintain your room. The standard set point for comfort condition in the residential zones is 24°C, but you can set a higher or lower temperature, if you wish.

The minimum allowable temperature is 16°C and the maximum is 31°C. You can use "Right" key to increase the value or "Left" key to decrease it (Refer to section 2.1 for "Right" and "Left" keys). As you change the value the result appears on the desired temperature section of the screen (Refer to section 2.2 to find the "Desired temperature" on the screen).

Note: If you set a value much lower than 24°C in summer or much higher in winter, it may cause your air conditioning device to work continuously. The set point which causes the device to work continuously depends on outside temperature, air conditioning device heating and cooling capacity, and some other factors related to your building.

Note: If you set a value much higher than 24°C in summer or much lower in winter, it may cause your air conditioning device not to start working. For a brief on the conditions which cause such a behavior refer to the previous note.

③ Season setting (Menu item 3)

Set the current season for the controller to work properly.

Setting the "summer" in this field causes the controller to switch the air conditioner on, if the room temperature is higher than desired.

In "winter" mode, the air conditioner switches on if the room temperature is lower than the desired.

Use "Right" or "Left" key to adjust the current season. The result appears at "Season setting" section of the screen (Refer to section 2.2 to find "Season setting" section of the screen and section 2.1. for "Right" and "Left" keys).

Notice: Not setting this field correctly may cause your air conditioner not to start working.

④ English / Local (Menu item 4)

It indicates language of the items of the status bar. If "English" is selected, all menu functions will appear in English. If local is selected, all menu functions of the status bar will appear in your local language.

⑤ Adjust hour (Menu item 5)

Use "Right" key to increase the current time hour or "Left" key to decrease it.

Note: It is necessary to adjust the current time correctly to ensure proper function of the program. Setting the time incorrectly, while program is enabled will cause the air conditioner malfunction.

⑥ Adjust minute (Menu item 6)

Use "Right" key to increase the current time minute or "Left" key to decrease it.

Note: It is important to set the current time correctly while the schedule program is enabled. Not setting the current time correctly will cause the device malfunction.

⑦ Adjust day (Menu item 7)

Press "Right" or "Left" key to adjust the current day.

Note: Not to adjust the current day while the program is enabled causes the device malfunction.

⑧ Enable/Disable program (Menu item 8)

It indicates that if the program is effective or not. Use "Right" key to enable or "Left" key to disable it. Using program schedule you can define two sets of air conditioner device off period including sleep and leave time.

You may preserve a significant amount of energy and enjoy silence during sleep time, due to absence of air conditioner device noises, by enabling the program schedule.

⑨ Schedule settings (Menu item 9)

Pressing either "Right" or "Left" key, leads you to schedule settings screen. Find more description about it in the next section.

2.4. To set the schedule program

Schedule program is the fundamental advantage of FP compared to SDT series. Enabling the schedule program, the air conditioner shuts down automatically when it's presence is no longer necessary and it restarts again at the preset time. FP series are provided with four time periods for each day, including wake up, leave, return and sleep periods. The schedule settings screen consists of two main sections, the upper part is the schedule itself, the last three rows of the screen contributes the command section.

2.4.1. Schedule section

The blinking cursor indicates the time period and the day. You may adjust the schedule time in hours by pressing "Right" or "Left" key. Each row title indicates the related time period and the column title indicates the related day. The FP series is provided with four time periods listed and described as below:

❶ "Wake up": It indicates the start time in hours of the air conditioner unit. The air conditioner shuts down automatically at the previous day sleep time setting. It restarts again at this time. You may increase the wake up time till the "Leave" time by pressing the "Right" key or decrease it till the midnight (0 o'clock) by pressing the "Left" key.

Note: "Up" key is not functional while you are at wake up setting.

Note: You may enter the "Leave" setting by pressing the "Down" key.

Note: When you enter the program schedule settings, the "Wake up" program for Monday will be selected automatically and the related cell starts to blink accordingly.

Note: You may set "Wake up" program an hour before the real wake up time to allow the room temperature to reach at the desired level when you wake up.

❷ "Leave": It is defined as the time in hours which all of the occupants leave the house for work and there is no need for air conditioner to continue the operation. So the air conditioner shuts down at this time. You may use "Right" key to increase it till the "Return" time or decrease it by pressing the "Left" key till the wake up time.

Note: You can move the cursor to the wake up program for the same day by pressing the "Up" key.

Note: You may move the cursor to the "Return" program for the same day by pressing the "Down" key.

Note: It is possible to bypass the working period of the air conditioner between wake up and leave time by selecting the same time for both.

Note: You may bypass the off period of the air conditioner between leave and return by selecting the same time for both programs. It may be suitable for holidays, when there is always someone in the house and you need the air conditioner to continue it's operation.

❸ "Return": Return program is defined as the time in hours when the first person returns home from work and you need the air conditioner to restart. Use the "Right" key to increase it up to the sleep time or "Left" key to decrease it till the leave time.

Note: Setting the same value for both the return and leave time causes the air conditioner not to shut down till the sleep time. Such a setting may be helpful during holidays, when there is always need for air conditioner to operate during the day.

Note: It is possible to bypass the working period program between return and sleep time by setting the same value for both. Such a setting may be useful for office environment where you can consider wake up program as the time work starts and "Leave" program as the time everyone leaves the office and you need the air conditioner to shut down.

Note: You may set the return time, one hour before your actual return time to let the temperature reaches to its desirable value for your presence.

Note: You may move to "Leave" program by pressing the "Up" key or to "Sleep" program by pressing the "Down" key.

CLIMASET

④ "Sleep": It is the time in hours you go to sleep and you like to eliminate air conditioner noises by shutting it down. Press the "Right" key to increase the value up to 24 o'clock or "Left" key to decrease it till the "Return" time.

Note: Setting 24 o'clock for sleep program and 0 o'clock for wake up time of the next day indicates that you want the air conditioner to continue it's operation during the night.

Note: By setting the same value for both return and sleep program, the device only starts at wake up time each day and stops working at the leave time. Such a setting may be useful for office environment.

Note: You may move to "Return" program of the same day by pressing the "Up" key or enter to "Previous/Next day" command of the commands section by pressing the "Down" key.

2.4.2. Commands section

① "Previous or Next day": If this command is selected the related row blinks as well as the column which represents the current day. You may choose the next day by pressing the "Right" key or previous day by pressing the "left" key.

Note: If you are currently in Monday you may enter to Sunday by pressing the "Left" key.

Note: If Sunday column is blinking you may choose the Monday as the current day by pressing the "Right" key.

Note: Pressing the "Down" key causes the "Copy to Previous/Next day" command to be selected.

3. Remote controller unit (FP 3-ir / 3x-ir only)

The remote controller utilizes infrared light waves to send the commands to the wall mounted unit. The light waves are effective at the maximum distance of 16 meters. The viewing angle for the remote controller is 30 degree. It means the wall mounted unit can still sense the commands even if remote controller deflects up to 30 degree from the wall mounted unit infrared sensor.

Note: All remote controllers use the same code, so you may use a single remote control with several wall mounted units.

Notice: Blocking the infrared lamp on the top of remote controller significantly reduces the range.

3.1. Installing batteries for remote controller

Locate the small latch on the battery compartment cover and push gently the latch in the direction of the arrow as illustrated below.

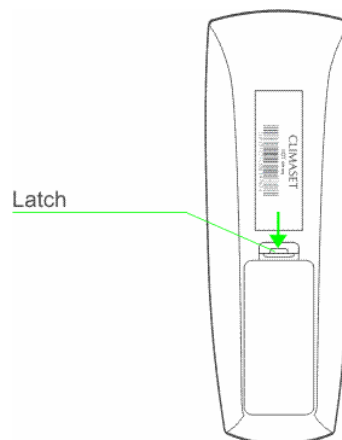

The cover releases. Lift off the cover to reveal the inner battery compartment.

Install two new AAA-size 1.5-volt alkaline, lithium or NiCad batteries with correct polarity following the illustration inside the battery compartment.

Warning: Mixing different battery types may cause explosion. Install same battery types each time you change them.

Replace the battery cover by inserting the prong into the slot at the bottom of the battery compartment and then pushing the cover until the latch snaps closed.

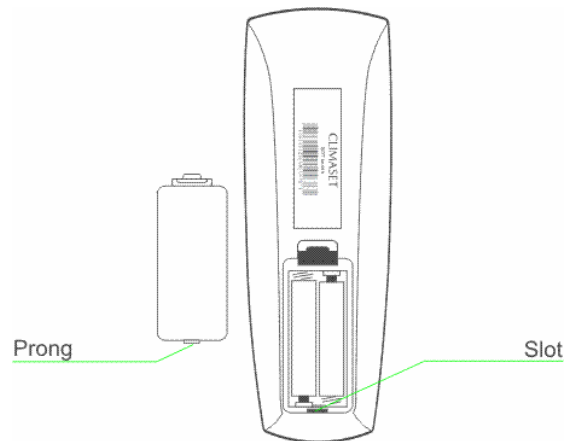

Press the "Wake up" key (Refer to section 3.2 for the "Wake up" key). The "Stand by" screen appears and the remote controller is functional (Refer to section 3.3.1 for "Stand by" screen).

Notice: Do not place objects on top of the remote control after installation of the batteries. Pressing the keys for an extended period of time reduces the battery life.

3.2. Keys

① "Up":

Use this key to increase the desired temperature.

② "Down":

Use this key to decrease the desired temperature.

③ "Right":

Use this key to increase the adjusted fan speed.

Notice: Pressing the "Right" key when the power status is off will switch it on and the minimum fan speed will be selected.

Notice: IF the maximum fan speed is selected pressing the "Right" key enters the device in "Auto" mode (FP 3x/3x-ir only) (Refer to section 2.2 for "Auto" mode).

④ "Left":

Use this key to decrease the adjusted fan speed.

Notice: By pressing "Left" key, while the minimum fan speed is selected, the "Power status" will be switched off.

Notice: By pressing "Left" key, when "Auto" mode is selected, the device exits from "Auto" mode and the maximum fan speed will be selected.

⑤ "Send": Use this key to transmit settings to the "Wall mounted" unit. After it recognizes the commands it will response by a beep sound. If the beep sound is not heard, you should repeat the transmission by pressing the "Send" key again.

Notice: If the beep sound is not heard after several attempts, it may be one of the following cases:

- You may too much far from the "Wall mounted" unit. Step toward the "Wall mounted" unit and try again.
- The deflection between remote controller and the "Wall mounted" unit is above the maximum allowable. Point the remote controller toward the "Wall mounted" unit.

-Batteries should be replaced with new ones.

-If none of the above is the case, please contact your dealer for customer service.

⑥ "Wake up": Activates the remote controller. The remote controller is equipped with auto power off feature in order to minimize power consumption. If you do not push any key for 3 minutes, it goes to "Sleep" mode.

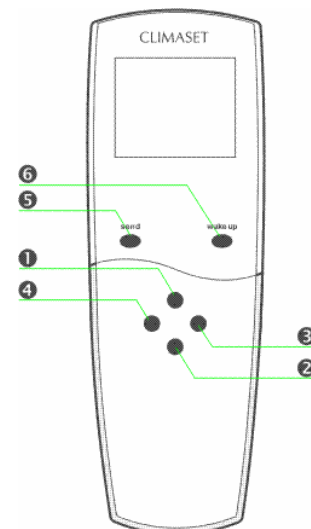

3.3. Screen elements

3.3.1. Stand by screen

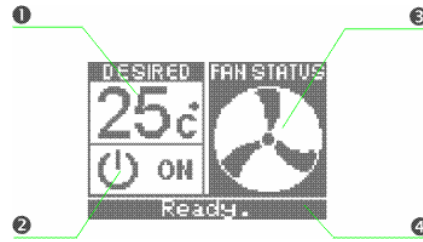

❶ Desired temperature: Your desired room temperature.

❷ Power status:

- ⏻ Air conditioner apparatus is on.
- ⏻ Air conditioner apparatus is off.

❸ Fan speed: It represents the adjusted fan speed. Use "Left" key to decrease the fan speed or "Right" key to increase it.

Note: If the fan speed is set to its minimum value and "Left" key is pressed the power status will be switched off. It switches on again by pressing the "Right" key.

Notice: Pressing the "Right" key while the maximum fan speed is selected enables the "Auto" mode (FP 3x/3x-ir only)(Please refer to section 2.2 for more description on "Auto" mode). You may exit the "Auto" mode by pressing the "Left" key in "Fan speed" menu, which cause the device to return to the maximum fan speed again.

▮ Status bar: It indicates messages about the last key you have just pressed for several seconds.

3.3.2 Good bye screen

If the remote controller is not used for about 3 minutes, it goes to the "sleep mode". Before it sleeps, "Good bye screen" will appear for some seconds.



3.4. List of status bar messages

- ❶ "Ready": Remote controller is ready for adjustments.
- ❷ "Temp. raised": By pressing "Up" key you have increased the "Desired" temperature.
- ❸ "Temp. dropped": By pressing "Down" key you have decreased the "Desired" temperature.
- ❹ "Fan spd. raised": By pressing the "Right" key you have increased the fan speed.
- ❺ "Fan spd. dropped": By pressing the "Left" key you have decreased the fan speed.
- ❻ "Power turned on": By pressing the "Right" key when the power status was off, you have switched on the power status.
- ❼ "Power turned off": By pressing the "Left" key when the minimum fan speed is selected, you have switched off the power status.
- ❽ "Auto selected" (FP 3x/3x-ir only): You have entered the automatic (Smooth approach) mode by pressing the "Right" key when the device was at maximum fan speed.

⑨ "Auto cleared" (FP 3x/3x-ir only): Automatic (Smooth approach) mode has been cleared after pressing the "Left" key when the device was in automatic mode.

⑩ "Not allowed": The message appears if you try to set the desired temperature above 31°C or below 16°C or by pressing "Right" key when the power status is on or "Left" key when the power status is off.

4. Installation guide

4.1. Mounting the wall mounted unit

Position the mounting plate on the wall. Level the mounting plate. Use a pencil to mark the mounting holes. Remove the plate from the wall and drill 3/16" holes in wall. Tap anchors into drilled holes. Reposition the plate and loosely insert two mounting screws into the holes. Level the plate for appearance. Tighten mounting screws.

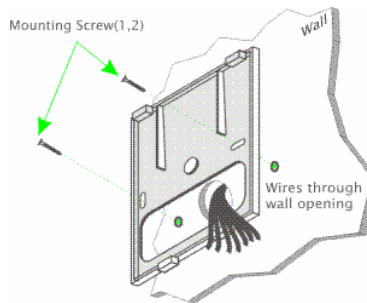

4.2. Proper wiring technique for the wall mounted unit

Please refer to the sketch below for the proper wiring technique. Also refer to section 4.5 for arrangement of the wires.

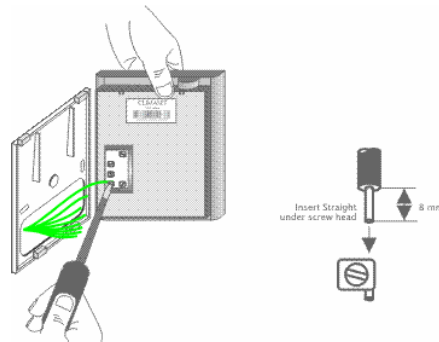

4.3. Engaging the wall mounted unit

Engage tabs at the top of the units and the wall plate. Gently press lower edge of the case to latch. To remove the "Wall mounted unit" from the wall, the top should be pulled out first.

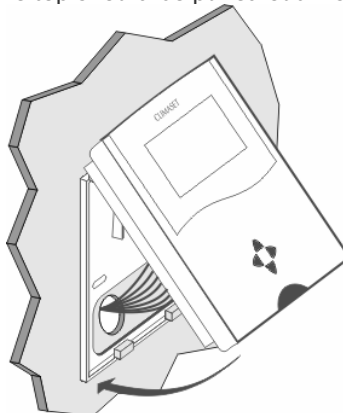

4.4. Wall mounted unit connectors

Connector Unit	Description	Input / Output	Electrical Characteristics
1	Phase	Input	AC220V/50Hz
2	Null	Input	Null
3	Fan high speed terminal	Output	AC220V/50Hz
4	Fan medium speed terminal	Output	AC220V/50Hz
5	Fan low speed terminal	Output	AC220V/50Hz

4.5. Wiring diagram

Please refer to sketch below for the wirings.

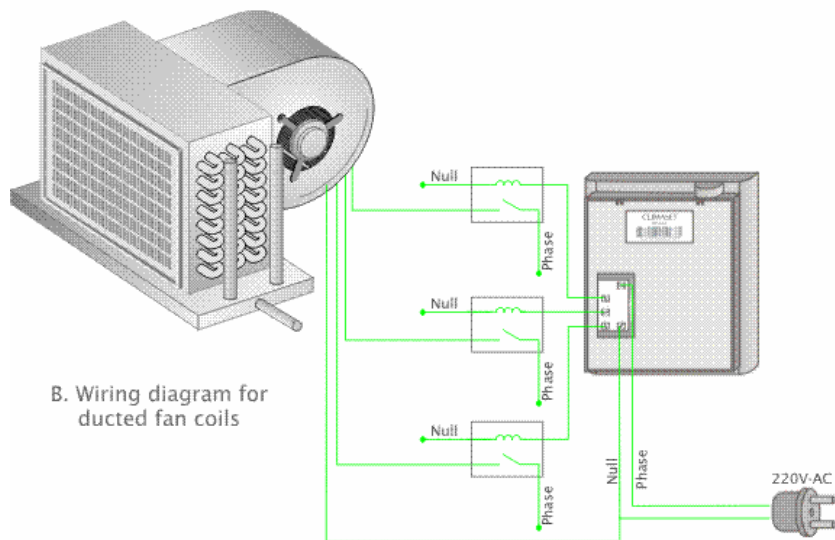
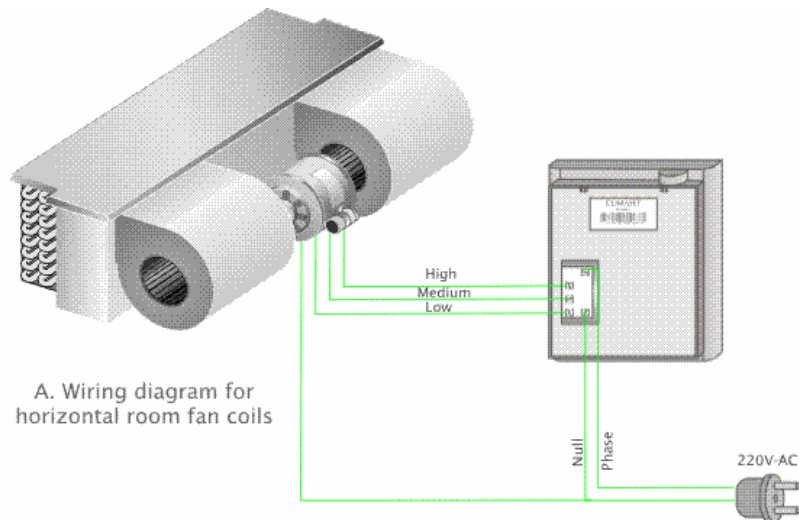

5. Care and maintenance

Care should be taken about the following items which may cause warranty obligation.

1. Keep the remote controller unit out of reach of children.
2. Do not use detergents or any chemicals to clean the Climaset. It may cause damages to electronic parts inside.
3. Climaset is designed to be used for residential comfort. Do not store it in hot or cold areas. Also it should not be stored in dirty or dusty environment.
4. Do not attempt to open any part of the Climaset. There is no part inside which you can service it. Ask your local dealer for services, if necessary.
5. Do not drop the remote controller. Take care in handling remote controller.
6. Keep the Climaset dry. Moisture can cause irreparable damages on electronic parts.

6. Specifications

Wall mounted unit	Temperature Sensitivity
	Display Resolution
	Backlight
	Display Width
	Display Length
	Width
	Length
	Height
Remote controller	Max. Effective Distance
	Max. Viewing Angle
	Display Resolution
	Display Width
	Display Length
	Width
	Length
	Height
	Battery Type
Operating condition	Temperature
	Humidity